

# The Y Factor Technique for Noise Figure Measurements

## Application Note

### Products:

R&S®FSW	R&S®FSV
R&S®FSQ*	R&S®FSU*
R&S®FSVR	R&S®FSMR
R&S®FSP*	R&S®FSUP
R&S®FSG*	R&S®FSL
R&S®FSWP	

This application note describes in detail the steps required to make a noise figure measurement on a spectrum analyzer using the “Y Factor” technique.

Background equations are presented for each step of the calculation. In addition, guidelines are provided to ensure a repeatable measurement. Measurement uncertainty is then reviewed, including contributions due to the noise source, analyzer, and the DUT itself.

Finally, a software utility is presented that automates the noise figure calculation using four measurements from a spectrum analyzer. The utility checks the measurement guidelines and highlights potential problem areas. It then calculates the noise figure and gain of the DUT along with the measurement uncertainty.

\*Discontinued products

# Table of Contents

<b>1</b>	<b>Introduction .....</b>	<b>3</b>
1.1	Definition of Noise Figure.....	3
1.2	Overview.....	4
1.3	Required Equipment .....	4
<b>2</b>	<b>Background Theory and Equations.....</b>	<b>5</b>
<b>3</b>	<b>Detailed Measurement Steps .....</b>	<b>9</b>
3.1	Calibration Step .....	10
3.2	Measurement Step .....	12
3.3	Calculation Step .....	13
<b>4</b>	<b>Selecting a Spectrum Analyzer and Noise Source.....</b>	<b>14</b>
<b>5</b>	<b>Automating the Measurement.....</b>	<b>15</b>
<b>6</b>	<b>Calculating Measurement Uncertainty .....</b>	<b>17</b>
6.1	Uncertainty in the Cascaded Noise Figure Result .....	18
6.2	Uncertainty in the Calibration of the Spectrum Analyzer Noise Figure.....	19
6.3	Uncertainty in the Gain Measurement of the DUT .....	19
6.4	Uncertainty in the ENR of the Noise Source .....	19
6.5	NF Measurement Uncertainty Example.....	19
<b>7</b>	<b>The Rohde &amp; Schwarz Noise Figure and Uncertainty Calculator.....</b>	<b>22</b>
7.1	Basic Usage of the Calculator.....	22
7.2	Showing Estimated Manually Measured Levels.....	24
7.3	Fully Manual Noise Figure Measurement .....	24
7.4	Using Measurement Guidelines to Ensure a Repeatable Result.....	25
7.5	Overview of Menus and Additional Features .....	26
<b>8</b>	<b>Ways to Improve Noise Figure Results .....</b>	<b>28</b>
<b>9</b>	<b>Conclusion.....</b>	<b>29</b>
<b>10</b>	<b>References.....</b>	<b>30</b>

# 1 Introduction

This application note describes in detail the steps required to make a noise figure measurement using a spectrum analyzer and the “Y Factor” technique. Background equations are presented for each step of the calculation. In addition, guidelines are provided to ensure a repeatable measurement. Measurement uncertainty is then reviewed, including contributions due to the noise source, analyzer, and the DUT itself.

Finally, a software utility is presented that automates the noise figure calculation using four measurements from a spectrum analyzer. The utility checks the measurement guidelines and highlights potential problem areas. It then calculates the noise figure and gain of the DUT along with the measurement uncertainty.

## 1.1 Definition of Noise Figure

The noise figure of a device provides a quantifiable measure of the noise that a device under test (DUT) adds to a signal as that signal passes through it. Stated another way, noise figure quantifies how much a DUT degrades the signal to noise ratio of a signal. It is a well defined, easy to measure, and common figure of merit found on specification sheets for different types of RF and microwave devices.

Consider a device with an input consisting of signal  $S_{in}$  plus noise  $N_{in}$  and gain  $G$ . The signal to noise ratio (SNR) at the input is  $S_{in}/N_{in}$ . Since  $S_{out} = S_{in}G$ , the SNR at the output is  $S_{in}G/N_{out}$  (see Figure 1).

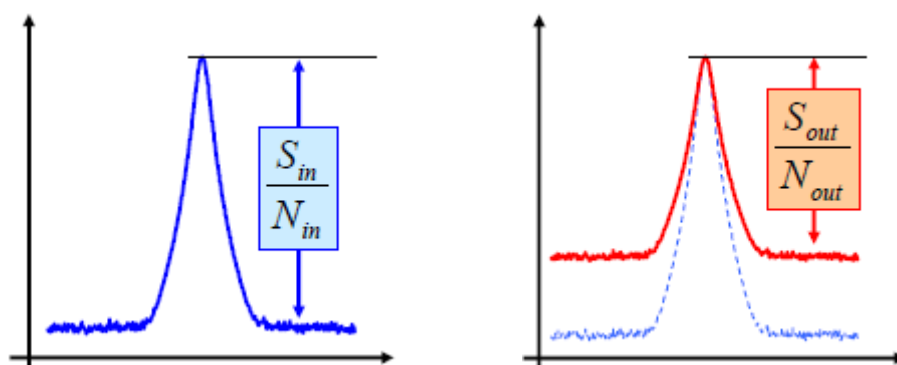

Figure 1: Graphical Representation of Signal to Noise Ratios at the input and output of a DUT.

The linear ratio of these quantities is the *noise factor*  $F$ . Converting noise factor to the log domain gives the more commonly used *noise figure*  $F_{dB}$ .

$$\text{Noise Factor: } F = \frac{N_{out}}{N_{in}G}$$

$$\text{Noise Figure: } F_{dB} = 10 \log \left( \frac{N_{out}}{N_{in}G} \right)$$

## 1.2 Overview

The measurement described in this application note uses the Y factor technique to measure noise figure with a spectrum analyzer. This technique utilizes a characterized broadband noise source that contains two temperature states: A high temperature state,  $T_{source}^{ON}$  with a higher output of noise power, and a low temperature state,  $T_{source}^{OFF}$  with reduced noise output. The noise source is applied to the DUT input and the noise power at the output of the DUT is measured for each of the two input noise states.

The noise figure and gain of the DUT are calculated from these measurements.

## 1.3 Required Equipment

Figure 2 shows a common setup for making a noise figure measurement. The required equipment is a spectrum analyzer and a noise source. The spectrum analyzer often contains a built in pre-amplifier. An integrated 28V DC port is a convenient addition to the spectrum analyzer and facilitates automation of the measurement process. This DC supply is used to turn the noise source on and off, switching it between its hot and cold states.

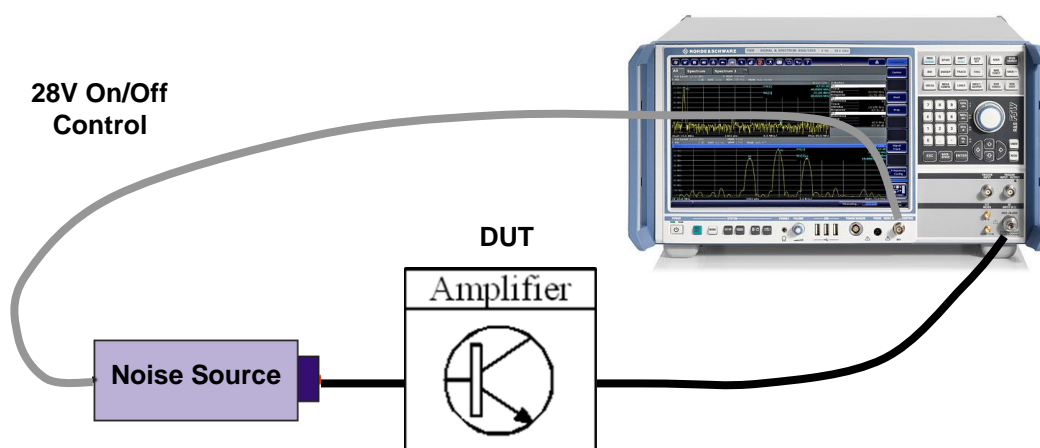

Figure 2: Common Setup to Measure Noise Figure.

## 2 Background Theory and Equations

To make a manual noise figure measurement using a spectrum analyzer there is a need to convert between different quantities such as noise figures, noise factors, noise temperatures, linear gain, log gain, linear power and log power. The equations needed for these conversions are listed in this section for reference.

As a convention, log parameters will be denoted with the suffix “dB” in the variable name and also in the units of the value. For an example, see equation (1).

Starting with a linear power,  $P$ , in units of watts, the first conversion required is to express the linear power as a log power. All log powers will be in units of dBm, which is a ratio of the linear power to 1 mW.

$$P_{dBm} = 10 \log \left( \frac{P}{0.001} \right) \quad (1)$$

The inverse relationship converts a log power “ $P_{dBm}$ ” to a linear power with units of watts.

$$P = (0.001) \cdot 10^{\left( \frac{P_{dBm}}{10} \right)} \quad (2)$$

In a similar way, linear noise factors “ $F$ ” are converted to log noise figures:

$$F_{dB} = 10 \log(F) \quad (3)$$

And the inverse equation is given as

$$F = 10^{\left( \frac{F_{dB}}{10} \right)} \quad (4)$$

Gain conversion utilizes this equation for linear gain,  $G$ , to log gain:

$$G_{dB} = 10 \log(G) \quad (5)$$

And the inverse equation is given as

$$G = 10^{\left( \frac{G_{dB}}{10} \right)} \quad (6)$$

Noise Figure (log) is related to Noise Temperature by equation (7).

$$T_{DUT} = T_0 \left( 10^{\left( \frac{F_{dB}}{10} \right)} - 1 \right) \quad (7)$$

Where  $T_0$  is the ambient temperature of the DUT. Noise Temperatures use the Kelvin scale.

The inverse equation follows as

$$F_{dB} = 10 \log \left( \frac{T_{DUT}}{T_0} + 1 \right) \quad (8)$$

Noise sources are commonly specified by their excess noise ratio, or ENR value, which is expressed in dB. The relationship between noise temperature and ENR is shown in equation (9). The calibrated ENR values supplied by the noise source manufacturer are generally referenced to  $T_0 = 290K$ .

$$ENR_{dB} = 10 \log \left( \frac{T_{source}^{ON} - T_{source}^{OFF}}{T_0} \right) \quad (9)$$

The conversion from ENR to an “on” temperature is then given by:

$$T_{source}^{ON} = T_0 \left( 10^{[ENR/10]} \right) + T_{source}^{OFF} \quad (10)$$

The remaining equations in this section are related to the Y factor method. The Y factor method uses the measured noise power at the DUT output with a room temperature noise source (noise source off) at the input, and with a high temperature noise source (noise source biased with 28V) at the input.

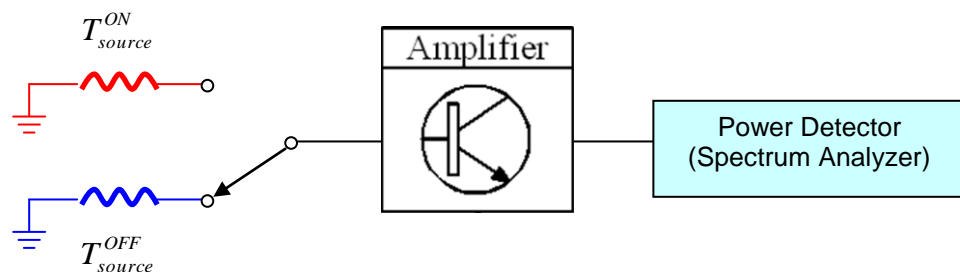

Figure 3: Diagram showing the Y factor noise figure variables.

These two measurements establish a line (see Figure 4) from which the DUT gain,  $G_{DUT}$ , can be determined. The Y-intercept indicates the noise added by the DUT,  $N_{DUT}$ . Figure 4 also includes variables for the bandwidth (in Hz) of the noise measurement,  $B$ , and Boltzmann's constant,  $k$  ( $1.38 \times 10^{-23}$  Joules/ $^{\circ}$ K).

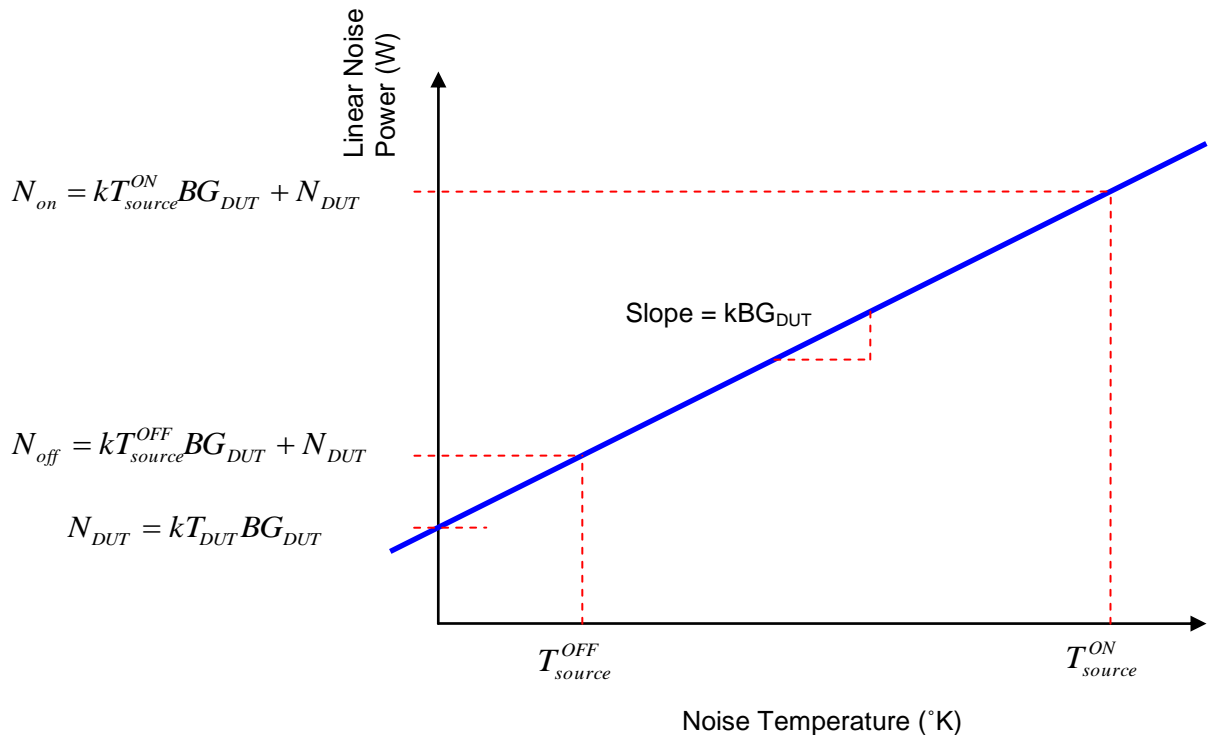

Figure 4: Diagram showing the Y factor variables.

The Y factor term can be found by taking the ratio of the measured (linear) noise power at the DUT output when the noise source is on and off.

$$Y = \frac{N_{on}}{N_{off}} \quad (11)$$

The Y factor can be used to calculate the noise temperature of the DUT with the following equation:

$$T = \frac{T_{source}^{ON} - Y \cdot T_{source}^{OFF}}{Y - 1} \quad (12)$$

Because the spectrum analyzer itself also makes a contribution to the overall noise result (due to its own noise figure), it is usually necessary to characterize the spectrum analyzer's noise figure (or linear noise factor), and then subtract it from the overall measurement by using the cascaded noise factor equation. This is often called second stage correction or calibration. In cases where the DUT has high gain and high noise figure and the spectrum analyzer has low noise figure the second stage error is negligible and the calibration step can be omitted. In most cases, however, second stage correction is recommended. Equation (13) is the linear form of the cascaded noise figure equation.

$$F_{DUT\&SA} = F_{DUT} + \frac{F_{SA} - 1}{G_{DUT}} \quad (13)$$

Both the noise figure of the spectrum analyzer and the noise figure of the cascade can be directly measured. The linear equation for the gain of the DUT is:

$$G_{DUT} = \frac{N_{on}^{DUT\&SA} - N_{off}^{DUT\&SA}}{N_{on}^{SA} - N_{off}^{SA}} \quad (14)$$

Equation (15) is used to calculate the noise temperature of the DUT from the gain of the DUT and the noise temperature of the second stage (which is the spectrum analyzer).

$$T_{DUT} = T_{DUT\&SA} - \frac{T_{SA}}{G_{DUT}} \quad (15)$$

Equation 16 shows a simplified form of the noise figure equation which results from combining equations (8), (9), and (12).

$$F_{dB} = ENR_{dB} - 10 \log(Y - 1) \quad (16)$$

Where Y is the measured Y factor as a linear ratio.



### 3 Detailed Measurement Steps

Noise Figure measurements with a spectrum analyzer consist of three main tasks: Calibration of the setup, measurement of the DUT, and calculation of the Noise Figure and Gain of the DUT.

The steps are listed below, along with the results obtained by making an example measurement on a small signal gain block at 1 GHz.

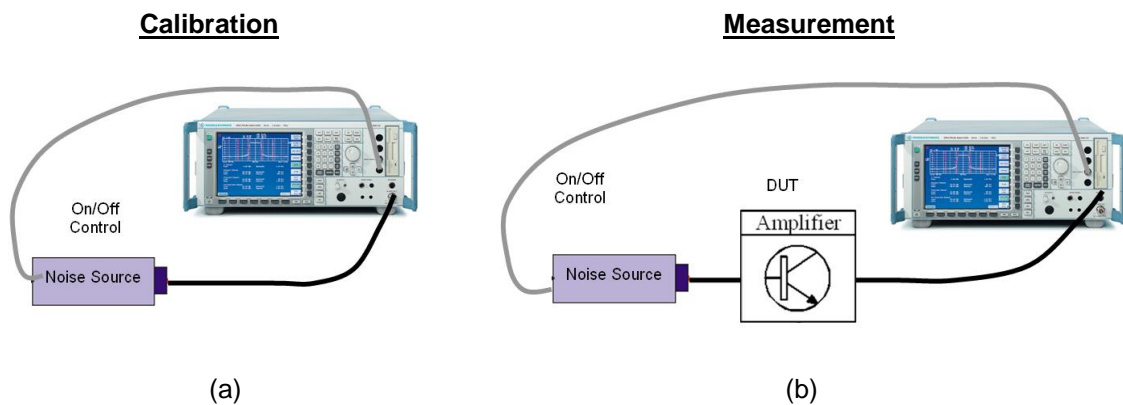

Figure 5: Connection diagram for (a) the calibration step, and (b) the measurement of the DUT's noise figure.

There are three primary steps for making the measurement

1. Calibration where the noise figure of the test equipment is measured
2. Measurement of the DUT cascaded with the test equipment.
3. Calculate of the DUT's parameters by using the cascaded noise figure equation.

Each of these are covered in more detail in the next section.

### 3.1 Calibration Step

1. Connect the equipment as shown in Figure 5a. (No DUT)
  - Connect the output of the noise source to the RF input of the spectrum analyzer.
  - Connect the noise source control of the spectrum analyzer to the noise source.
2. Enter the following settings on the spectrum analyzer:
  - Set the spectrum analyzer to the desired test frequency
    - (For example: 990 to 1010 MHz)
  - Set the RBW to be less than the BW of the DUT
    - (For example: 1 MHz)
  - Enable the preamplifier in the spectrum analyzer.
  - Set the RF attenuator to 0 dB.
  - Set the Reference level to a fairly low value
    - (For example: -80 dBm.)
  - Set the Log range to a fairly low value
    - (For example: 30 dB.)
  - Select the RMS detector,
  - Select a slower sweep time to RMS average the results.
    - (For example: 1 second.)
3. Use equation (10) to find the temperature of the noise source when it is on. Generally the ENR value of the noise source is printed directly on the source in a table. Assume the room temp  $T_0 = 290K$ , and the off state temperature is also 290K. As an example, the noise source used during this test has an ENR value of 14.66 dB at 1 GHz.

$$T_{source}^{OFF} = 290K$$

$$T_{source}^{ON} = T_0 \left( 1 + 10^{[14.66/10]} \right)$$

$$= 8770.0K$$

4. Turn the noise source off and measure the noise power of the trace on the spectrum analyzer using a marker. Convert to linear noise power using equation (2). Measurement on a Rohde & Schwarz spectrum analyzer yielded -104.5 dBm of noise power. Note that 1 femtowatt (fW) =  $1 \times 10^{-15}$  W.

$$N_{off\_dB}^{SA} = -104.5dBm$$

$$N_{off}^{SA} = 35.48fW$$

5. Turn the noise source on, measure the noise power of the trace using a marker. Convert to linear noise power using equation (2). An example measurement on a Rohde & Schwarz spectrum analyzer had a noise power reading of -97.6 dBm during this step.

$$N_{on\_dB}^{SA} = -97.6dBm$$

$$N_{on}^{SA} = 173.8fW$$

6. Calculate the linear Y factor using equation (11). Notice that the units and the impact of the selected resolution bandwidth cancel out of the Y factor term. This is an advantage of the Y factor technique.

$$Y_{SA} = \frac{N_{on}^{SA}}{N_{off}^{SA}}$$

$$Y_{SA} = \frac{173.8}{35.48}$$

$$Y_{SA} = 4.898$$

7. Then use equation (12) to solve for the noise temperature of the spectrum analyzer

$$T_{SA} = \frac{T_{source}^{ON} - Y_{SA} \cdot 290}{Y_{SA} - 1}$$

$$T_{SA} = \frac{8770.0 - 4.898 \cdot 290}{4.898 - 1}$$

$$T_{SA} = 1885.6K$$

8. Finally, convert the noise temperature of the spectrum analyzer into a noise figure by using equation (8).

$$NF_{dB}^{SA} = 10 \log \left( \frac{1885.6}{290} + 1 \right)$$

$$NF_{dB}^{SA} = 8.75dB$$

9. Or use the ENR value and the Y factor along with equation (16) to calculate the NF directly

$$NF_{dB}^{SA} = 14.66 - 10 \log(4.898 - 1)$$

$$NF_{dB}^{SA} = 8.75dB$$

## 3.2 Measurement Step

In this step the cascaded noise figure of the device under test and the spectrum analyzer are measured. Start by connecting the DUT between the noise source and the spectrum analyzer as shown in Figure 5b.

1. Turn the noise source off and measure the noise power of the trace. In this example, the small signal amplifier connected to the Rohde & Schwarz spectrum analyzer had an output power level of -93.63 dBm.

$$N_{off\_dB}^{DUT\&SA} = -93.6dBm$$

$$N_{off}^{DUT\&SA} = 436.5 fW$$

2. Turn the noise source on and measure the noise power of the trace. The DUT plus spectrum analyzer had a level of -82.58 dBm in this step.

$$N_{on\_dB}^{DUT\&SA} = -82.5dBm$$

$$N_{on}^{DUT\&SA} = 5623 fW$$

3. Use equation (11) to calculate the linear Y factor of the cascade.

$$Y_{DUT\&SA} = \frac{5623}{436.5}$$

$$Y_{DUT\&SA} = 12.88$$

4. Then use equation (12) to solve for the noise temperature of the cascade.

$$T_{DUT\&SA} = \frac{T_{source}^{ON} - Y_{DUT\&SA} \cdot 290}{Y_{DUT\&SA} - 1}$$

$$T_{DUT\&SA} = \frac{8770.0 - 12.88 \cdot 290}{12.88 - 1}$$

$$T_{DUT\&SA} = 423.7 K$$

5. Convert the cascaded noise temperature into a noise figure with equation (8).

$$NF_{dB} = 10 \log \left( \frac{T_{DUT\&SA}}{T_0} + 1 \right)$$

$$NF_{dB} = 10 \log \left( \frac{423.7}{290} + 1 \right)$$

$$NF_{dB} = 3.91dB$$

6. Or use equation (16).

$$NF_{dB} = 14.66 - 10\log(12.88 - 1)$$

$$NF_{dB} = 3.91dB$$

### 3.3 Calculation Step

In the final step calculate the gain and the noise figure of the DUT by applying the cascaded noise figure equations.

1. Use equation (14) to calculate the linear gain of the DUT. This is another equation where the units and the impact of the selected resolution bandwidth cancel.

$$Gain_{DUT} = \frac{5623 - 436.5}{173.8 - 35.48}$$

$$Gain_{DUT} = 37.51$$

2. Use equation (5) to convert to a log gain

$$Gain_{DUT} = 10\log(37.51)$$

$$Gain_{DUT} = 15.74dB$$

3. Use the equation (15) to calculate the noise temperature of the DUT

$$T_{DUT} = T_{DUT\&SA} - \frac{T_{SA}}{Gain_{DUT}}$$

$$T_{DUT} = 423.7 - \frac{1885.6}{37.51}$$

$$T_{DUT} = 373.4K$$

4. And finally calculate the noise figure with equation (8)

$$NF_{dB} = 10\log\left(\frac{373.4}{290} + 1\right)$$

$$NF_{dB} = 3.59dB$$

## 4 Selecting a Spectrum Analyzer and Noise Source

Below are three guidelines to use when selecting a noise source and a spectrum analyzer for making a noise figure measurement. The purpose of the guidelines is to ensure there are adequate deltas between the four individual measurements described in 3.1 and 3.2. This minimizes the effect of the inherent noise (non-repeatability) of the individual measurements. Satisfying these guidelines will help ensure an accurate and repeatable measurement.

1. The first guideline addresses the two measurements of the calibration step. We would like the difference between the noise source on and off measurements to be at least 3dB. To accomplish this we must choose a noise source with ENR at least 3dB greater than the noise figure of the spectrum analyzer.

$$ENR_{dB} > NF_{dB}^{SA} + 3dB$$

The section 3 example satisfies this criterion:

$$14.66dB > 8.75dB + 3dB$$

$$14.66dB > 11.75dB$$



2. The second guideline addresses the two measurements of the measurement step. Here, we would like the difference between the noise source on and off measurements to be at least 5dB. To accomplish this we must choose a noise source with ENR at least 5dB greater than the noise figure of the DUT.

$$ENR_{dB} > NF_{dB}^{DUT} + 5dB$$

The section 3 example satisfies this guideline:

$$14.66dB > 3.59dB + 5dB$$

$$14.66dB > 8.59dB$$



3. The third guideline addresses the deltas between the measurement and calibration steps. We would like these differences to be at least 1dB and this is done by choosing the spectrum analyzer and preamp such that the noise figure of the DUT + the gain of the DUT is at least 1dB greater than the noise figure of the spectrum analyzer.

$$NF_{dB}^{DUT} + GAIN_{dB}^{DUT} > NF_{dB}^{SA} + 1dB$$

The section 3 example satisfies this guideline:

$$3.59dB + 15.74dB > 8.75dB + 1dB$$

$$19.33dB > 9.75dB$$



Since all three guidelines were satisfied, the Y factor calculation should yield a repeatable result.

## 5 Automating the Measurement

Most modern spectrum analyzers offer a personality that will make the noise figure measurement automatically. It will take care of the calibration and measurement steps, solve the equations, and plot the resulting noise figure and gain of the device under test on a frequency plot.

In addition to this, the Noise Figure personality from Rohde & Schwarz also factors in any losses at the input and output of the DUT, compensating for items such as matching pads, isolators or attenuators. The impact of the temperature of the noise source on the ENR value is also compensated automatically. And measurements on frequency converting devices, such as a mixer or a receiver (RF to IF) front end, are also supported.

Figures 6, 7 and 8 are screen shots that show a typical noise figure measurement from a Rohde & Schwarz FSV spectrum analyzer.

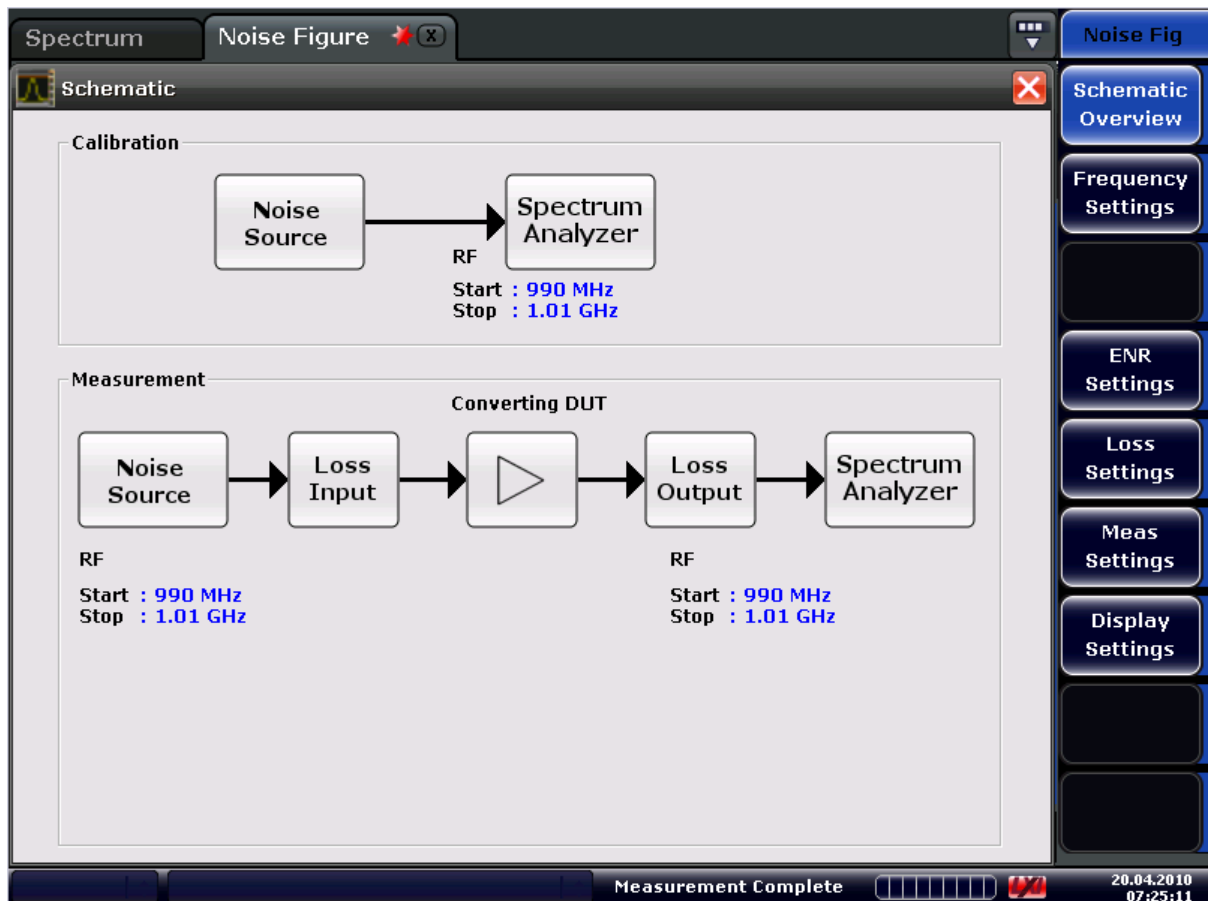

Figure 6: Configuration window for making noise figure measurements on a Rohde & Schwarz FSV spectrum analyzer

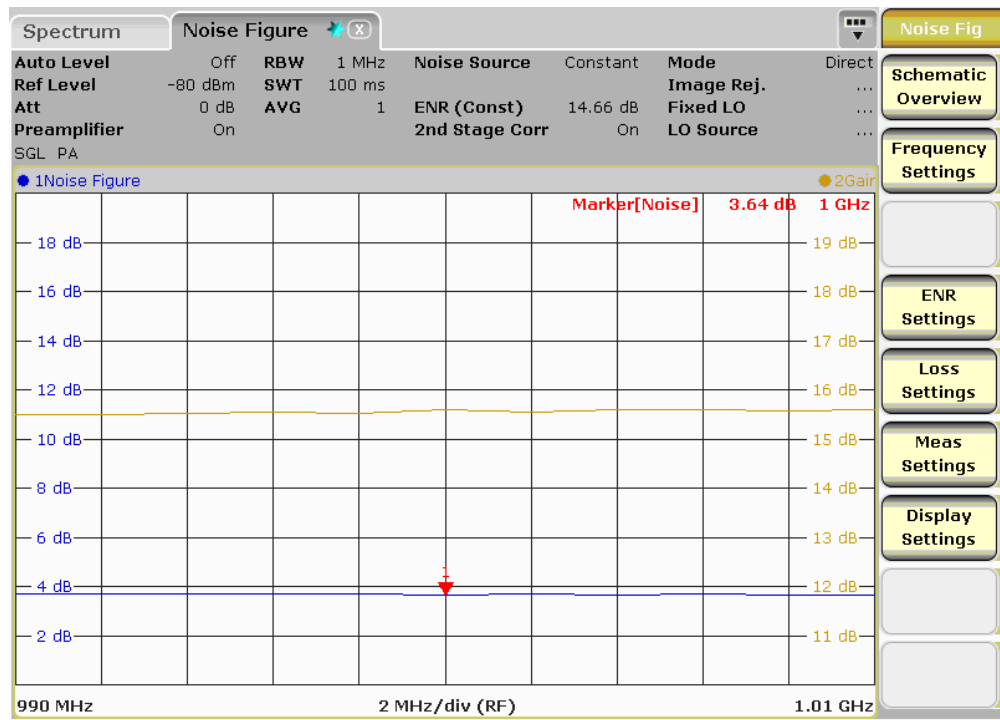

Figure 7: Resulting plot of the noise figure and gain of the DUT.

RF	NF	Noise Temp	Gain
990.000 MHz	3.683 dB	387.224 K	15.489 dB
992.000 MHz	3.672 dB	385.458 K	15.489 dB
994.000 MHz	3.672 dB	385.391 K	15.518 dB
996.000 MHz	3.673 dB	385.553 K	15.543 dB
998.000 MHz	3.692 dB	388.586 K	15.513 dB
1.000 GHz	3.640 dB	380.492 K	15.591 dB
1.002 GHz	3.707 dB	390.847 K	15.538 dB
1.004 GHz	3.642 dB	380.742 K	15.589 dB
1.006 GHz	3.682 dB	386.979 K	15.592 dB
1.008 GHz	3.657 dB	383.110 K	15.575 dB
1.010 GHz	3.650 dB	382.089 K	15.587 dB

Fixed Frequency (Meter)			
Frequency	Noise Figure	Gain	
1 GHz	3.64 dB	15.591 dB	

Figure 8: Tabular summary of the noise figure, noise temperature and gain of the DUT.



## 6 Calculating Measurement Uncertainty

Noise figure measurement uncertainty is a key consideration when making a noise figure measurement. The noise figure measurement will be meaningless if the measurement uncertainty is too large. Knowing the uncertainty of the noise figure measurement adds value especially when comparing measurement results. Consider the two devices below. Which is preferred?

DUT	Noise Figure
Supplier One	1.257 dB
Supplier Two	1.4 dB

Seemingly the amplifier with the lower noise figure (and also listed with more digits of precision) would be the obvious choice. But adding measurement uncertainty values to the table may change the natural conclusion.

DUT	Noise Figure	NF Uncertainty
Supplier One	1.257 dB	+/- 0.5 dB
Supplier Two	1.4 dB	+/- 0.1 dB

Uncertainty can be calculated in either a worst case scenario by adding up all the contributions to the overall uncertainty, or by using the Root of the Sum of the Squares (RSS) approach. In general, when the contributions are independent from each other, the RSS approach is utilized in practice as a more realistic bound on uncertainty. In a noise figure uncertainty calculation the contributions are independent making the RSS approach the appropriate selection.

Several factors contribute to noise figure measurement uncertainty. The noise figure of the spectrum analyzer, uncertainty of the noise source ENR value, and gain of the DUT have significant impact. Impedance mismatches between noise source and DUT, DUT and spectrum analyzer, and noise source and spectrum analyzer (during the calibration step) also add to the overall uncertainty.

While it is relatively easy to identify sources of measurement uncertainty, it is more difficult to distill the effects down to an overall uncertainty equation. The work has been done in reference [3] by applying differential analysis to the cascaded noise figure equation. The results are summarized in equation 17.

$$\text{Measurement Uncertainty} = \sqrt{
 \begin{aligned}
 &\left( \frac{F_{DUT\&SA}}{F_{DUT}} \Delta F_{DUT\&SA\_dB} \right)^2 \\
 &+ \left( \frac{F_{SA}}{F_{DUT} G_{DUT}} \Delta F_{SA\_dB} \right)^2 \\
 &+ \left( \frac{F_{SA} - 1}{F_{DUT} G_{DUT}} \Delta G_{DUT\_dB} \right)^2 \\
 &+ \left( \left( \frac{F_{DUT\&SA}}{F_{DUT}} - \frac{F_{SA}}{F_{DUT} G_{DUT}} \right) \Delta ENR_{dB} \right)^2
 \end{aligned}
 } \quad (17)$$

It is important to note that in equation 17 the four delta terms  $\Delta F_{DUT\&SA\_dB}$ ,  $\Delta F_{SA\_dB}$ ,  $\Delta G_{DUT\_dB}$ ,  $\Delta ENR_{dB}$  are in units of dB, and correspond to the four "primary contributions" of measurement uncertainty. The equations for these terms are covered in detail in the next section.

The remaining terms are combinations of the linear ratios of the measured noise factor and gain of the DUT, noise factor of the spectrum analyzer, and the cascaded noise factor of the spectrum analyzer and DUT. These values are all measured or calculated during the noise figure measurement process described in section 3. Note that equation 17 assumes the calibration step is performed and that the DUT is a linear device such as an amplifier. For frequency converting DUTs the uncertainty of the noise source ENR at the input and output frequencies must be taken into account and the measurement uncertainty equation is slightly different. The remainder of this section applies to the linear (non-frequency converting) case.

## 6.1 Uncertainty in the Cascaded Noise Figure Result

The cascaded noise figure measurement consists of two measurements to determine the cascaded Y factor. During these measurements two parameters dominate the error terms:

1. The mismatch between the noise source and the input of the DUT, which creates a standing wave on the transmission line.
2. The uncertainty of the spectrum analyzer's reported noise figure results.

Mismatch calculations are well known, and the resulting error is understood to be:

$$mismatch\_error_{dB} = \pm 20 \log(1 \mp \Gamma_{source} \Gamma_{DUT\_input})$$

The reflection coefficients of the noise source and the DUT are usually specified or easily measured.

The noise figure uncertainty of the Spectrum Analyzer is specified by the spectrum analyzer manufacturer.

Since the mismatch error and noise figure uncertainty are independent from each other, the root sum square (RSS) method is used to add them together. The resulting error term for the measurement of the cascaded noise figure is shown in equation (18). This result (in units of dB) is needed to complete equation (17).

$$\Delta F_{DUT\&SA\_dB} = \sqrt{\left(20 \log(1 - \Gamma_{source} \Gamma_{DUT\_input})\right)^2 + \left(SA_{NF\_uncertainty\_dB}\right)^2} \quad (18)$$

## 6.2 Uncertainty in the Calibration of the Spectrum Analyzer Noise Figure

The next error term, uncertainty in the noise figure measurement of the spectrum analyzer during calibration, is similar to the first term and follows as:

$$\Delta F_{SA\_dB} = \sqrt{\left(20\log(1 - \Gamma_{source}\Gamma_{SA\_input})\right)^2 + \left(SA_{NF\_uncertainty\_dB}\right)^2} \quad (19)$$

This term (in units of dB) is also needed to calculate equation (17).

## 6.3 Uncertainty in the Gain Measurement of the DUT

The third term is the uncertainty in the gain measurement of the DUT. This term is impacted by all three combinations of mismatch between the noise source, the DUT input and output ports, and the spectrum analyzer. It is also affected by the noise figure uncertainty of the spectrum analyzer.

$$\Delta G_{DUT\_dB} = \sqrt{\left(20\log(1 - \Gamma_{source}\Gamma_{SA\_input})\right)^2 + \left(20\log(1 - \Gamma_{source}\Gamma_{DUT\_input})\right)^2 + \left(20\log(1 - \Gamma_{DUT\_output}\Gamma_{SA\_input})\right)^2 + \left(SA_{gain\_uncertainty\_dB}\right)^2} \quad (20)$$

## 6.4 Uncertainty in the ENR of the Noise Source

The fourth term is the uncertainty of the noise source ENR values supplied by the manufacturer. This uncertainty is typically specified by the noise source supplier, and is generally in the area of 0.1 dB to 0.2 dB.

$$\Delta ENR_{dB} \cong 0.2 \quad (21)$$

## 6.5 NF Measurement Uncertainty Example

Assume the following reflection coefficients:

noise source:	0.05	(26 dB return loss)
DUT input	0.251	(12 dB return loss)
DUT output	0.316	(10 dB return loss)
SA input	0.2	(14 dB return loss)

Assume SA NF is measured as 12 dB. (noise factor of 15.85)  
 Assume the DUT gain is 15 dB (gain of 31.62)  
 Assume NF of DUT and SA cascade is 7.85 dB (noise factor of 6.095)  
 therefore DUT noise figure is calculated as 7.5 dB (noise factor of 5.62)  
 Assume SA noise figure uncertainty is 0.05 dB  
 Assume SA gain uncertainty is 0.059 dB

Assume the ENR uncertainty is 0.2 dB.

Using equation 18:

$$\begin{aligned}\Delta F_{DUT\&SA\_dB} &= \sqrt{(0.1097)^2 + (0.05)^2} \\ &= 0.1245dB\end{aligned}$$

And from equation 19:

$$\begin{aligned}\Delta F_{SA\_dB} &= \sqrt{(0.0873)^2 + (0.05)^2} \\ &= 0.1053dB\end{aligned}$$

Equation 20:

$$\begin{aligned}\Delta G_{DUT\_dB} &= \sqrt{(0.1097)^2 + (0.0873)^2 + (0.567)^2 + (0.059)^2} \\ &= 0.587dB\end{aligned}$$

And Equation 21:

$$\Delta ENR_{dB} = 0.2$$

The required linear ratios are:

$$\frac{F_{DUT\&SA}}{F_{DUT}} = \frac{6.095}{5.62} = 1.085$$

$$\frac{F_{SA}}{F_{DUT}G_{DUT}} = \frac{15.85}{(5.62)(31.62)} = 0.0892$$

$$\frac{F_{SA} - 1}{F_{DUT}G_{DUT}} = \frac{15.85 - 1}{(5.62)(31.62)} = 0.0836$$

$$\frac{F_{DUT\&SA}}{F_{DUT}} - \frac{F_{SA}}{F_{DUT}G_{DUT}} = \frac{6.095}{5.62} - \frac{15.85}{(5.62)(31.62)} = 0.996$$

Substitution of the values into equation 17 results in an overall Noise Figure Uncertainty of:

$$\begin{aligned} &= \sqrt{((1.085)(.125))^2 + ((.0892)(.105))^2 + ((.0836)(.587))^2 + ((.996)(.2))^2} \\ &= 0.243dB \end{aligned}$$

## 7 The Rohde & Schwarz Noise Figure and Uncertainty Calculator

While the measurement guidelines presented in Section 4 are fairly straightforward to evaluate, the noise figure measurement uncertainty is very tedious to calculate manually. To make this task easier, Rohde & Schwarz provides a Noise Figure and Uncertainty Calculator along with this application note (free-of-charge from the R&S website). This calculator is intended for use on a Microsoft Windows 7 or Windows XP operating system. It is a stand alone executable program and does not utilize an installer. The application consists of a single window that calculates noise figure measurement uncertainty and evaluates the measurement guidelines. The user simply enters the pertinent parameters for the noise source, DUT, and analyzer. There is also the option to calculate noise figure and gain from the manual measurements described in Section 3.

### 7.1 Basic Usage of the Calculator

The main function of the calculator is to estimate noise figure measurement uncertainty and to evaluate the measurement guidelines. The measurement uncertainty is based on the following user-entered parameters:

- Noise Source Output Match (VSWR or Return Loss)
- Noise Source ENR Uncertainty (dB)
- DUT Input and Output Match (VSWR or Return Loss)
- DUT Noise Figure and Gain (dB)
- Spectrum Analyzer Input Match (VSWR or Return Loss)
- Spectrum Analyzer Noise (Noise Figure or DANL)
- Spectrum Analyzer Gain Uncertainty and Noise Figure Uncertainties (dB)

The measurement guidelines are based on these user-entered parameters:

- Noise Source ENR (dB)
- DUT Noise Figure and Gain (dB)
- Spectrum Analyzer Noise (Noise Figure or DANL)

The noise figure measurement uncertainty and measurement guidelines are updated immediately when any parameter is changed.

The user may enter the noise source parameters manually (User) or choose a specific model from the noise source drop down list (see Figure 9). When a model is chosen its specified output match and nominal ENR will be automatically entered. The match is frequency dependent so it will change with the entered frequency. The ENR value is device specific so only the nominal ENR for the selected model is set.

Similarly, the spectrum analyzer values may be entered manually (User) or a spectrum analyzer model may be chosen from the drop down list. When a spectrum analyzer model is chosen the specified input match, DANL, gain uncertainty and noise figure uncertainty are set. If the selected model has an internal preamp option the "Int PA" checkbox will be enabled and, when checked, the proper DANL will be set accordingly.

The input match and DANL values are frequency dependent so they will change with the entered frequency. In addition to the internal preamp selection, the user may evaluate the effect of an external preamp by selecting the Ext PA checkbox. When selected the user can enter the gain and noise figure of the external preamp. Also, the *Analyzer Input Match* field becomes *Ext PA Input Match*.

When a noise source or spectrum analyzer model is selected the values set are guaranteed, not typical. Actual performance will likely be better than these worst-case values.

The uncertainty calculation is slightly different when measuring a frequency converting device. The utility has a check box to indicate this type of DUT. When the “Freq Conv” box is checked there will be two frequency fields for input and output frequencies. Note that if the noise source and spectrum analyzer are both set to “User” the Frequency field is irrelevant and will not be used in any calculations.

When analyzer noise is entered as DANL the utility converts it to equivalent noise figure for the uncertainty calculation using the formula:  $NF = DANL + 173.98\text{dBm} + 2.51\text{dB} - 0.27\text{dB}$  (173.98dBm is kTB at 290K, 2.51dB is the correction for sample detection and log averaging used for DANL specs, and 0.27dB is the equivalent noise bandwidth correction for the 1kHz digital Gaussian RBW filter used for DANL specs).

Two additional, but usually small contributors to measurement uncertainty are the spectrum analyzer gain and noise figure uncertainties. If a specific model spectrum analyzer is selected these values are entered automatically. The user can hide these values by selecting *Option* → *Hide SA Uncertainties* from the menu, but they are still used in the uncertainty calculation.

Noise figure measurements of high-gain devices are sometimes done without calibration since the noise added by the second stage (analyzer) is insignificant. The user has the option to view the effects of omitting second stage correction by de-selecting “Enable 2<sup>nd</sup> Stage Correction” from the Option menu. This will eliminate the calibration step from the uncertainty calculation and show the measurement offset error (always positive) due to the uncorrected second stage. Note that when second stage correction is disabled the measurement guidelines are not displayed.

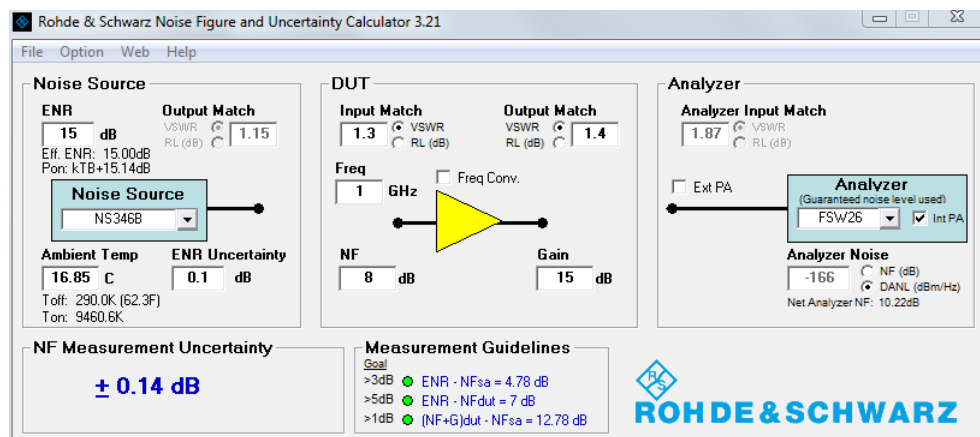

Figure 9: Rohde & Schwarz Noise Figure and Uncertainty Calculator. NS346A Noise Source and FSW26 Spectrum Analyzer with Internal Preamp are selected.

## 7.2 Showing Estimated Manually Measured Levels

The utility has the additional capability of showing estimated levels of the four underlying measurements described in Section 3. These values are estimated from the Noise Source ENR, DUT Noise Figure and Gain, and Analyzer Noise. Select “Show Manual Measurement Values” from the Options menu to view these values (see Figure 10). Note that the four absolute levels are only estimates since the absolute levels are dependent on spectrum analyzer resolution bandwidth, filter shape factor, losses, etc. However, the deltas between the levels and correspondingly,  $Y_{cal}$ ,  $Y_{meas}$ ,  $NF_{sa}$ ,  $NF_{(dut+sa)}$  are accurate.

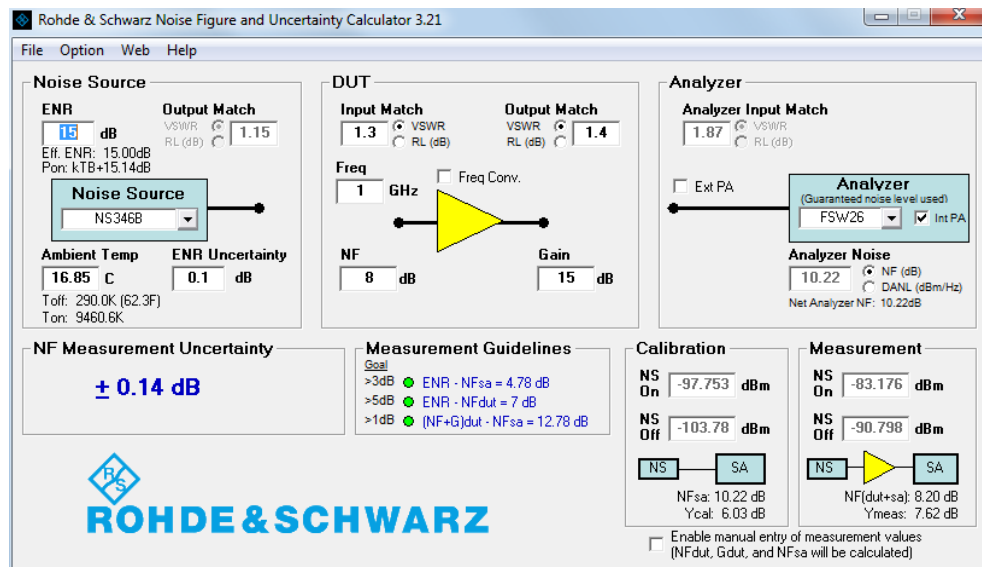

Figure 10: Noise Figure and Uncertainty Calculator with estimated measurement values enabled.

## 7.3 Fully Manual Noise Figure Measurement

The utility can also perform the calculations described in Section 3 to implement a fully manual noise figure measurement. The calibration and measurement fields will be enabled for user entry if the check box labeled “Enable manual entry of measurement values” is checked (see Figure 11).

The parameters used to calculate the DUT noise figure, gain and analyzer noise are:

- ENR value (dB)
- Ambient Temperature of the Noise Source (degrees C)
- Noise floor measurement of Analyzer with noise source “off” (dBm)
- Noise floor measurement of Analyzer with noise source “on” (dBm)
- Noise measurement of DUT output with noise source “off” (dBm)
- Noise measurement of DUT output with noise source “on” (dBm)



DUT noise figure and gain are updated as these values are entered as well as noise figure measurement uncertainty and measurement guidelines. In addition, the noise figure of the spectrum analyzer is displayed in the bottom of the “Calibration” section and the cascaded noise figure of the DUT and the analyzer is displayed in the bottom of the “Measurement” section.

ENR values provided by the manufacturer or calibration lab are referenced to an ambient temperature of 290°K. Often, however, the actual ambient temperature during a measurement is not 290°K. The “Ambient Temp” field provides a means to enter the actual ambient temperature of the noise source so the noise figure is correctly calculated using the effective ENR and  $T_{on}$  values (displayed in noise source area). Referring back to Figure 4, the change in ambient temperature can be visualized by horizontally shifting the vertical  $T_{off}$  and  $T_{on}$  points together, while the slope and y-intercept of the measured blue line remain unchanged.

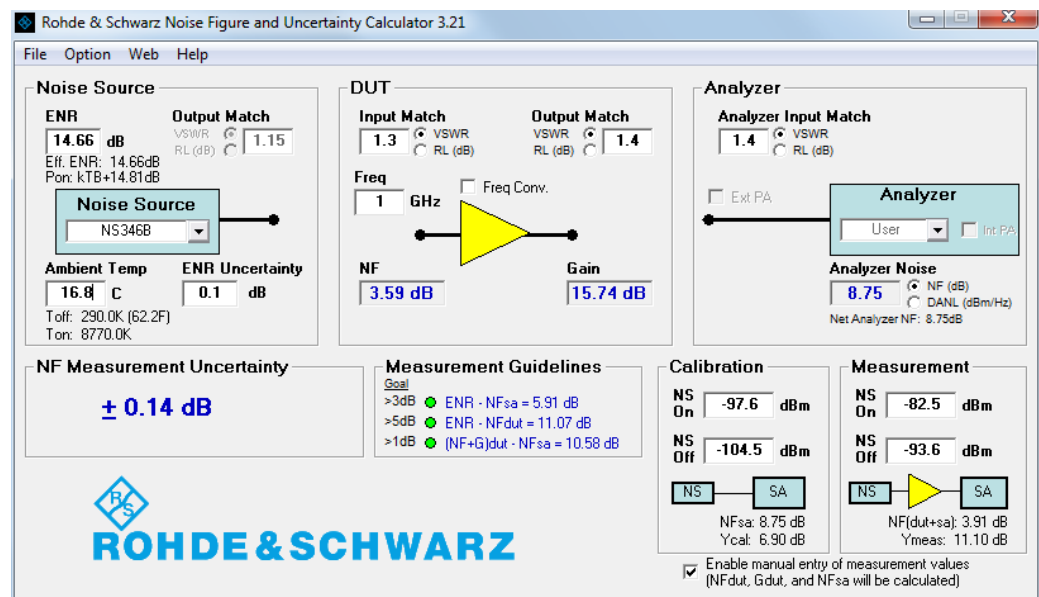

Figure 11: Calculator with manual measurement entry enabled showing example from Section 3.

## 7.4 Using Measurement Guidelines to Ensure a Repeatable Result

The measurement guidelines presented in Section 4 are evaluated based on DUT noise figure and gain, and analyzer noise figure, and ENR. These guidelines give an indication of the quality of the measurement. The compliance to each of the guidelines is indicated as follows:

- Green light: Guideline condition met
- Yellow light: Guideline condition not met, but within 1dB of being met
- Red light: Guideline condition not met

The goal for the user is to choose a noise source, spectrum analyzer, and preamp so that all three Measurement Guidelines are marked with a green light. Note that the

noise source ENR will affect guidelines 1 and 2 and the spectrum analyzer/preamp (internal or external) combination will affect guidelines 1 and 3. It may appear that higher ENR is always better, however noise sources with higher ENR also have worse VSWR which can degrade uncertainty so it's best to choose a noise source with the lowest ENR necessary to satisfy the guidelines. For the spectrum analyzer, lower noise figure is always better. Figure 12 shows an example where guidelines 1 and 3 are not being met. This is an indication that the noise figure of the analyzer is not low enough to make a quality measurement and a preamp (internal or external) should be considered.

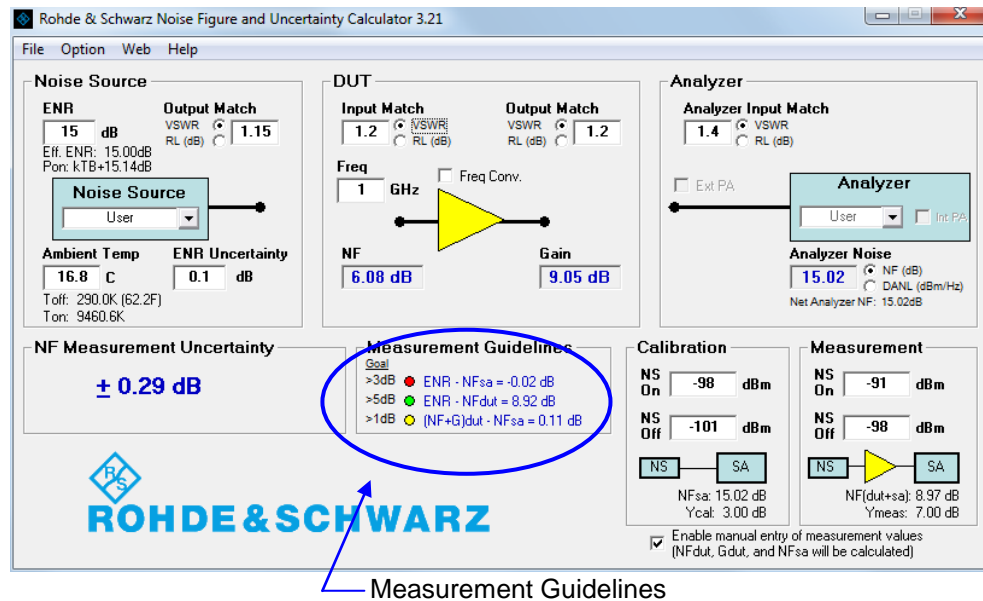

Figure 12: Example Demonstrating the use of the Measurement Guidelines.

## 7.5 Overview of Menus and Additional Features

In addition to calculating uncertainty and measurement guidelines, the utility makes it easy to evaluate the sensitivity of the noise figure measurement uncertainty to each of the various contributors. Any parameter may be incremented by highlighting the parameter and pressing the Cntl-Up Arrow (+0.01dB), Up Arrow (+0.1dB), or Shift-Up Arrow (+1dB) keys. The down arrow key is similarly used to decrement the highlighted parameter. By shifting individual parameters by 0.1dB and monitoring the uncertainty value the user may quickly evaluate the sensitivity of measurement uncertainty to each parameter. This provides a simple method for quickly determining which parameters have the most significant effect on the measurement uncertainty and where improvements might be made.

The uncertainty result display has a default resolution of 0.01dB, but the user can choose resolutions from 0.1dB to 0.0001dB by clicking anywhere in the NF Measurement Uncertainty area and selecting the desired resolution. Select UI Hints in the Help menu to show all keyboard shortcuts (see Figure 13).

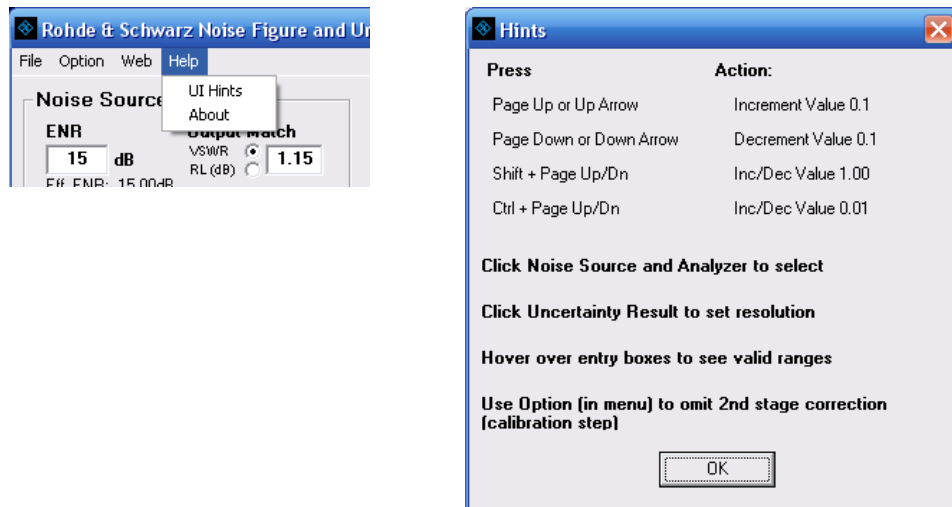

Figure 13: UI Hints are available under the Help Menu.

Most user entered parameters are protected against invalid entries (e.g. VSWR < 1, ENR < 0, etc.), however, error conditions can arise if certain combinations of values are entered. If an error does occur the utility will indicate in red what the problem is and which parameter should be addressed (see Figure 14).

The situations that can cause such an error are:

- DUT Noise Figure < -DUT Gain (i.e.  $NF < Loss$ )
- NS On Level  $\leq$  NS Off Level (Calibration or Measurement)
- Measurement NS Off Level < Calibration NS Off Level

The File menu has three selections. “Reset to Startup Values” resets the program to the original values without changing any optional settings. “Preset” resets all aspects of the utility to startup conditions. “Exit” closes the application.

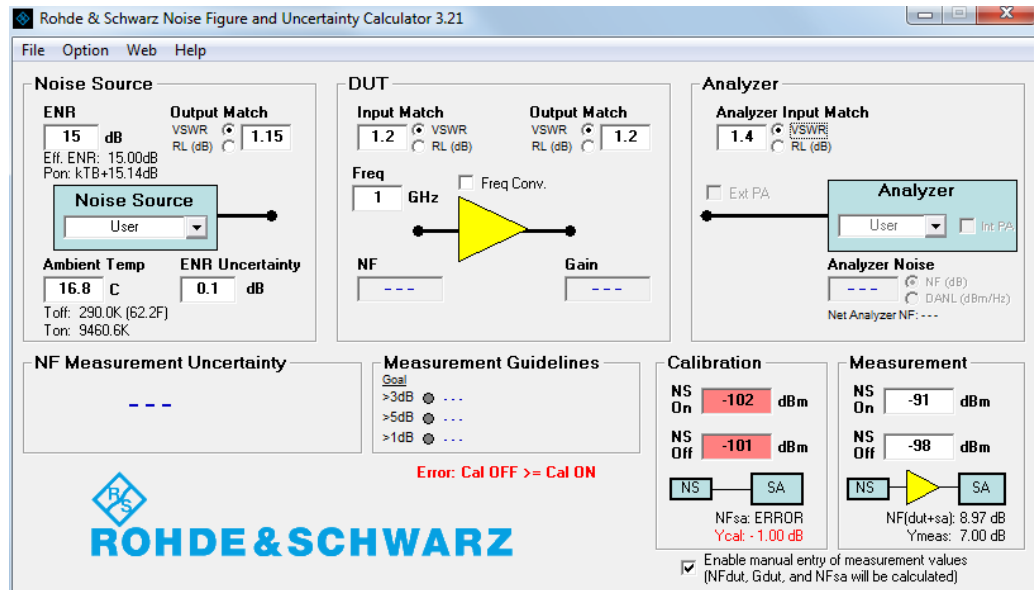

Figure 14: Example showing error condition (Calibration NS Off level > NS On level).

The Web menu contains a list of links for R&S Noise Figure option pages, Noise Source product pages, and related Application Notes.

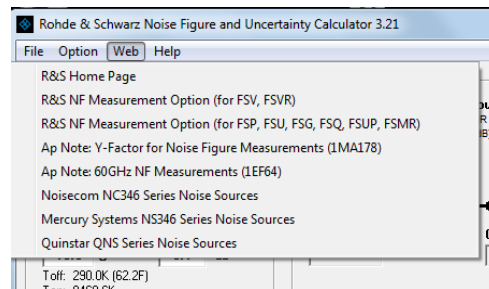

Figure 15: The Web Menu contains links to some useful web sites that are related to noise figure measurements.

## 8 Ways to Improve Noise Figure Results

There are several possible remedies if the calculated uncertainty does not meet the requirements of the application. Usually, the largest contributor to measurement uncertainty is the noise figure of the spectrum analyzer. Without a preamp, typical spectrum analyzers have over 20dB noise figure. Fortunately, most spectrum analyzers offer an optional internal preamp that significantly improves the analyzer noise figure. In fact, a preamp (internal or external) is almost always required for good noise figure measurements.

For example, if a DUT has 5dB noise figure and 10dB gain, a mid-range spectrum analyzer without a preamp can result in a noise figure measurement uncertainty of more than 6dB! The internal preamp improves this to 0.7dB. An external preamp with high gain and low noise figure will yield even further improvement. The preamp (internal, external, or both) is treated as part of the measurement system and is calibrated out of the measurement along with the rest of the second stage contributions.

Mismatches also contribute to the uncertainty. Small attenuators or isolators may be added to minimize mismatch and improve the uncertainty. These components must be included during the calibration step so they will be accounted for in the measurement. Also, noise sources with lower ENR values generally have better match performance.

In addition to minimizing measurement uncertainty, we want to maximize measurement repeatability. We do this by ensuring that the measurement setup satisfies the three measurement guidelines presented in Section 4. Using a spectrum analyzer and preamp to get a low resulting measurement system noise figure is always desirable. However, choosing an optimum noise source takes a little more investigation since higher ENR noise sources have worse match characteristics. Good match improves uncertainty, but high ENR improves repeatability.

## 9 Conclusion

It is fairly straightforward to make noise figure measurements with a noise source and a spectrum analyzer. The manual process may be tedious, but can yield accurate results. Guidelines are provided to ensure a repeatable measurement with a known uncertainty. Rohde & Schwarz offers a software utility that calculates the noise figure and the uncertainty based on the measurement conditions. The uncertainty calculator allows many measurement scenarios to be quickly evaluated for accuracy.

In addition to the manual process, most modern spectrum analyzers (and all current Rohde & Schwarz spectrum analyzers) offer a noise figure personality. The noise figure personality automates all the steps of the measurement, providing the user with the noise figure and gain of the DUT in graphical and tabular form.

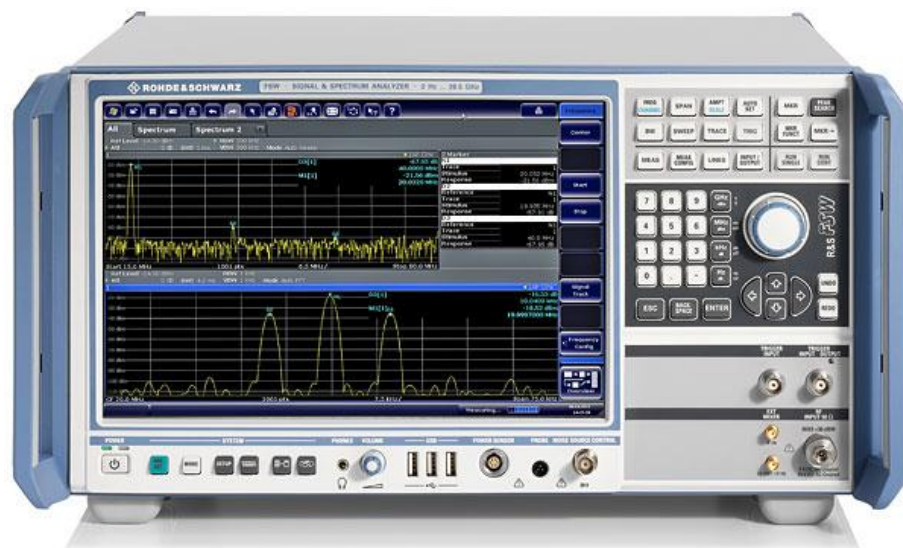

*Figure 16:* The Rohde & Schwarz FSW spectrum analyzer. This is an ideal instrument for making Noise Figure measurements due to its low noise figure, available built-in pre-amplifier and noise source control.

## 10 References

- [1] D. M. Pozar, "Microwave Engineering", John Wiley and Sons, 1998.
- [2] C. Rauscher, "Fundamentals of Spectrum Analysis", Rohde & Schwarz, 2005.
- [3] L. Colby and B. Heinz, "Accuracy of Noise Figure Measurement Systems", RF & Microwave Symposium and Exhibition, Hewlett Packard, 1988.
- [4] D. Boyd, "Calculate the Uncertainty of NF Measurements", Microwaves and RF, October, 1999, page 93.
- [5] Rohde & Schwarz, "FSU Operating Manual", Rohde & Schwarz, 2003.
- [6] W. Wendler and B. Muro, "Noise Figure Measurement in the 60 GHz Range", Rohde & Schwarz Application Note 1EF64, 2009.
- [7] S. Neidhardt, M. Beer, A. Paech, "ZVAB-K30 Noise Figure Measurement Option", Rohde & Schwarz Application Note 1EZ61, 2010.

## Rohde & Schwarz

The Rohde & Schwarz electronics group offers innovative solutions in the following business fields: test and measurement, broadcast and media, secure communications, cybersecurity, radiomonitoring and radiolocation. Founded more than 80 years ago, this independent company has an extensive sales and service network and is present in more than 70 countries.

The electronics group is among the world market leaders in its established business fields. The company is headquartered in Munich, Germany. It also has regional headquarters in Singapore and Columbia, Maryland, USA, to manage its operations in these regions.

## Regional contact

Europe, Africa, Middle East  
+49 89 4129 12345  
[customersupport@rohde-schwarz.com](mailto:customersupport@rohde-schwarz.com)

North America  
1 888 TEST RSA (1 888 837 87 72)  
[customer.support@rsa.rohde-schwarz.com](mailto:customer.support@rsa.rohde-schwarz.com)

Latin America  
+1 410 910 79 88  
[customersupport.la@rohde-schwarz.com](mailto:customersupport.la@rohde-schwarz.com)

Asia Pacific  
+65 65 13 04 88  
[customersupport.asia@rohde-schwarz.com](mailto:customersupport.asia@rohde-schwarz.com)

China  
+86 800 810 82 28 | +86 400 650 58 96  
[customersupport.china@rohde-schwarz.com](mailto:customersupport.china@rohde-schwarz.com)

## Sustainable product design

- Environmental compatibility and eco-footprint
- Energy efficiency and low emissions
- Longevity and optimized total cost of ownership

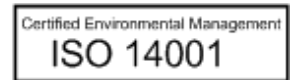

This application note and the supplied programs may only be used subject to the conditions of use set forth in the download area of the Rohde & Schwarz website.

R&S® is a registered trademark of Rohde & Schwarz GmbH & Co. KG; Trade names are trademarks of the owners.

**Rohde & Schwarz GmbH & Co. KG**  
Mühlhofstraße 15 | 81671 Munich, Germany  
Phone + 49 89 4129 - 0 | Fax + 49 89 4129 - 13777

[www.rohde-schwarz.com](http://www.rohde-schwarz.com)